



# ZONING ADMINISTRATOR BULLETIN NO. 1 REPEALED

## Developing Ground Floor Accessory Rooms In Residential Buildings REPEALED ON MARCH 22, 2021



Section 307 of the Planning Code mandates the Zoning Administrator to issue and adopt such rules, regulations and interpretations as are in the Zoning Administrator's opinion, necessary to administer and enforce the provisions of the Planning Code. [Section 7.502 of the San Francisco Charter charges the Zoning Administrator with the responsibility of administering and enforcing the Planning Code.]

Date: <b>JUNE 1993</b>	Relevant Code Sections: <b>102.7 (the Definition of Dwelling Unit)</b> <b>174 (Compliance with Conditions)</b>
Reprinted: <b>OCTOBER 2009</b>	Formerly known as: Zoning Administrator Bulletin No. 1993-01

### RULING:

In order to allow property owners to efficiently and cost-effectively add livable space to their homes, but to hinder the creation of illegal residential units, proposals to develop ground-floor rooms in residential buildings shall be reviewed according to a set of standards summarized in the Matrix below. These standards take into account 1) whether the building is proposed for new construction or is existing and proposed for alteration; 2) the type of access from the proposed rooms to the street and 3) the type of visual and spatial connection proposed between the ground floor rooms and rooms on the main floor of the unit (usually the floor above the ground floor). Terms used in the matrix are defined on Pages 2, 3, and 4 with graphic examples and a brief explanation or how to use the matrix is found on Pages 5.

Matrix for Developing Rooms on the Ground Floor

 Permitted  
 Choose 1 of 2 Options  
 Not Permitted

Interior Connection to Main Floor Occupancy	Room Use	NEW BUILDING Accessibility to Street		ALTERATION Accessibility to Street	
		DIRECT	INDIRECT	DIRECT	INDIRECT
OPEN Visual Spatial Connection between Floors	Full Bath	Permitted	Permitted	Permitted	Permitted
	Half Bath	Permitted	Permitted	Permitted	Permitted
	Wet bar	Permitted	Permitted	Permitted	Permitted
	Laundry Sink	Permitted	Permitted	Permitted	Permitted
LIMITED Visual Spatial Connection between Floors	Full Bath	Permitted	Permitted	Permitted	Permitted
	Half Bath	Permitted	Permitted	Permitted	Permitted
	Wet bar	Permitted	Permitted	Permitted	Permitted
	Laundry Sink	Permitted	Permitted	Permitted	Permitted
TOTAL LACK Visual Spatial Connection between Floors	Full Bath	Permitted	Permitted	Permitted	Permitted
	Half Bath	Permitted	Permitted	Permitted	Permitted
	Wet bar	Permitted	Permitted	Permitted	Permitted
	Laundry Sink	Permitted	Permitted	Permitted	Permitted

# REPEALED

## Matrix Definitions

In addition to the types of room uses listed in the matrix which are all served by plumbing, non-habitable storage rooms and habitable living areas not served by plumbing lines are also allowed.

**OPEN VISUAL AND SPATIAL CONNECTION BETWEEN FLOORS** – refers to a stair or other opening that allows an open, unobstructed view from habitable areas on the principal floor of occupancy to habitable rooms of the ground-level. There are no doors at either floor of the opening, nor could doors be easily added. A stairway with a completely open railing from top to bottom is a typical example. See illustrations to the right.

Figure 1

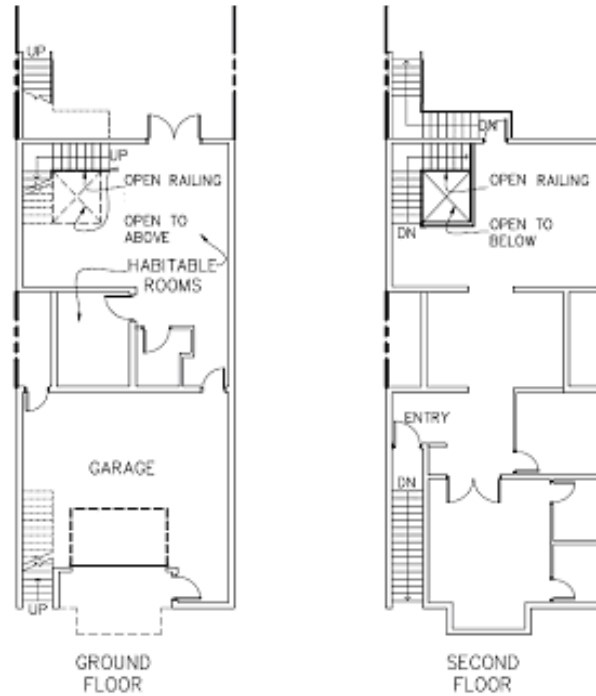
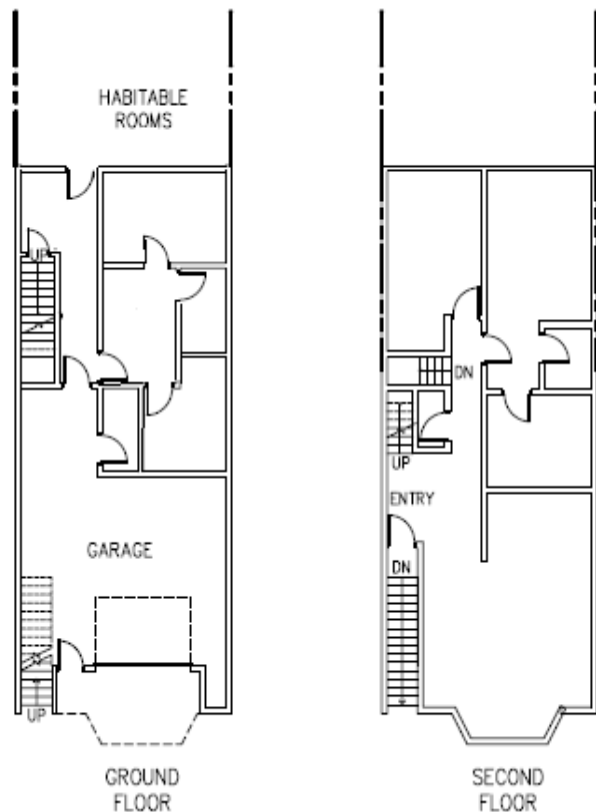

Figure 2



**LIMITED VISUAL AND SPATIAL CONNECTION BETWEEN FLOORS** – refers to a stair or other opening that provides direct access between the principal floor of occupancy and habitable areas of the ground floor but not necessarily an open view between these floors. Walled stairways with doors or with openings which could easily accommodate a door at one or both ends is a typical example. See illustrations to the right.

# REPEALED

Figure 3

**TOTAL LACK OF VISUAL AND SPATIAL CONNECTION BETWEEN FLOORS** – refers to a situation where there is neither direct access nor open, unobstructed view between habitable areas of the principal floor of occupancy and habitable areas of the ground floor. Examples include stairways that lead from the principal floor to non-habitable areas such as the garage. See illustrations to the right.

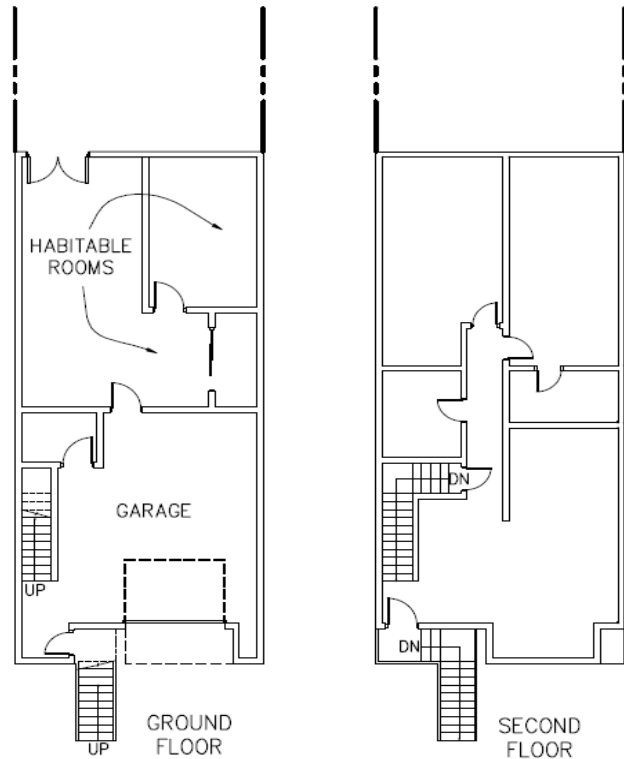
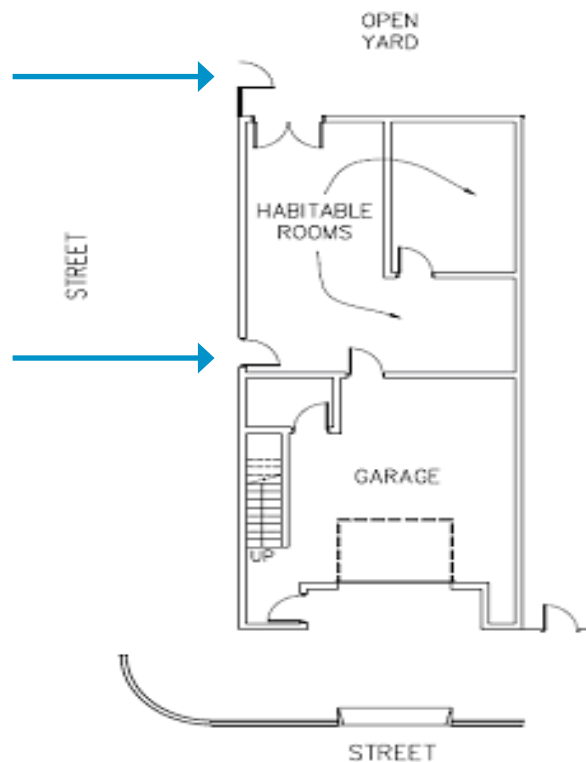

Figure 4

**ACCESSIBILITY TO THE STREET** – refers to how one exits and enters the ground floor rooms in order to get outside the building. Access is classified as either **DIRECT** or **INDIRECT**, defined below.

**DIRECT ACCESS** – refers to doors which lead directly from habitable areas of the ground floor to the front yard or to the street or to rear yards or side yards when those rear yards or side yards lead directly to the street. See illustration to the right.



# REPEALED

**INDIRECT ACCESS** – refers to doors which only lead from habitable areas of the ground floor to the garage or to other interior common areas (such as laundry rooms which serve one or more upper floor units) or to outdoor areas which do not lead directly to the street. See illustration to the right.

*\*NOTE – when there is no access from habitable ground floor rooms which lead either directly or indirectly to the street, ground floor rooms can include all types of rooms listed in the Matrix*

Figure 5

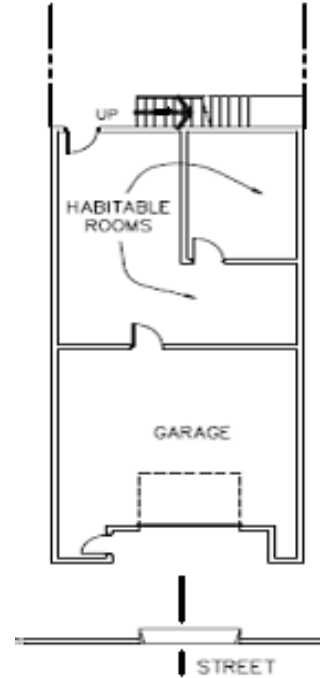
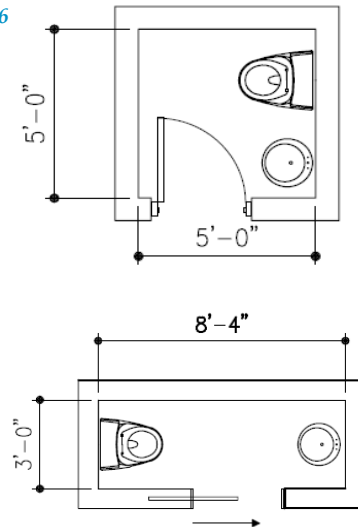
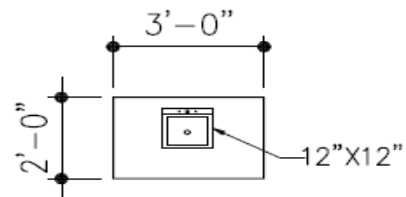

Figure 6



**HALF BATH** - refers to a bathroom that does not have a shower or a bathtub and which is not larger than 25 square feet in area.

Figure 7



**WET BAR** – a sink not exceeding 12 inches in width and length, allowed with a counter top not exceeding three feet in length.

# REPEALED

## How to Use the Matrix

- 1) If the rooms are part of a new building proposed for construction (i.e., the entire building has not been constructed yet), use the two columns of the matrix labeled “NEW BUILDING”. If the rooms are proposed for an existing building, use the two columns of the matrix labeled “ALTERATION”.
- 2) Next determine the type of interior connection between the ground and upper floor that exists (or is proposed) – “OPEN”, “LIMITED” OR “TOTAL LACK” – and use the rows to the right where you will see four features listed.
- 3) Finally, determine whether the access from the ground floor rooms is “DIRECT” or “INDIRECT” and look down that column.

This will be considered **indirect** access in a single- family house.

This will be considered **direct** access in a building that has two or more units.

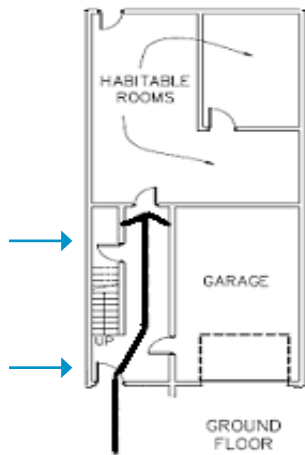

### Example:

Your existing house has no stairway between the ground floor and the floor above. The access from the ground floor to the street is indirect (i.e., the only way to get from these rooms to the street is through the garage). Using the columns labeled “ALTERATION” and “INDIRECT” (access) and the rows labeled “TOTAL LACK of visual/spatial connection between floors”, you see that you can have either a full bath or a wet bar and a half bathroom and laundry room. If you want to have both a full bath and a wet bar you could find portions of the matrix where they are permitted (such as in the “OPEN visual and spatial connection” row) and propose to add the required features (such as an open stairway).

Note that the standards in the matrix will be applicable in most cases; however, there may be some unusual circumstances which warrant additional or alternate standards, Code section 307 authorizes the Zoning Administrator to make such determinations. Additionally, the Zoning Administrator may require property owners to record a Notice of Special Restriction on the property title in order to assist in enforcement of code requirements and to clarify the legal use of ground floor rooms for current and future property owners.

The Rooms Down Matrix tells us what features are permitted in instances where there is direct and indirect access. Both types of access are generally defined. However, there is a common type of situation which the definitions do not address. This situation is where there is a common area (other than a non-habitable area such as a garage) between the rooms and the upper story. See illustration above. Some planners see this situation as direct access and others see it as indirect. After due consultation and consideration, **I have determined that in single-family buildings such a situation for now shall be deemed indirect access and in two or more unit buildings this situation shall be deemed direct access.**



**San Francisco  
Planning**

**FOR MORE INFORMATION:  
Contact the San Francisco Planning Department**

**Central Reception**  
49 South Van Ness Avenue, Suite 1400  
San Francisco, CA 94103

TEL: **628.652.7600**  
WEB: **www.sfplanning.org**

**Planning counter at the Permit Center**  
49 South Van Ness Avenue, 2nd Floor  
San Francisco, CA 94103

EMAIL: **pic@sfgov.org**  
TEL: **628.652.7300**